

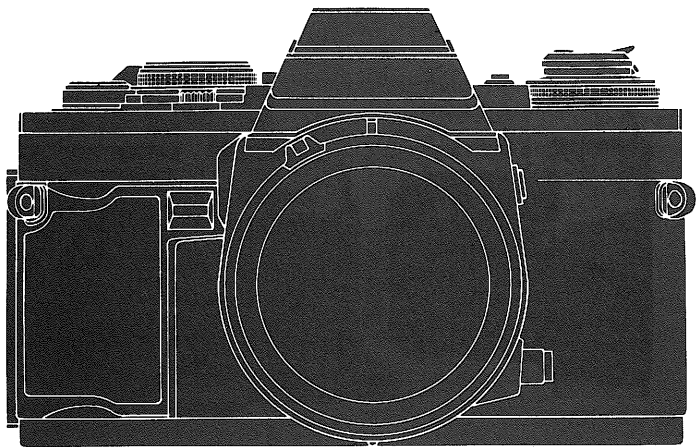

XG-M

OWNER'S MANUAL

E



Your compact XG-M is the center of one of the most comprehensive and versatile photographic systems ever created. It offers aperture-priority automatic exposure control for greatest creative control and ease of use. You can also set the exposure manually, with or without reference to the camera's calculation. The aperture selected and LED shutter-speed setting are clearly displayed in the XG-M's total information viewfinder whose acute matte screen makes viewing brighter and focusing easier and more accurate. Electromagnetic shutter release, unique "touch-switch" metering and action grip are among the many other features of this fine camera. Motorized film advance is available in two ways: the grip-type Motor Drive 1 for exposures up to 3.5 frames per second and the compact Auto Winder G for single/continuous film advance up to 2 frames per second. Minolta's X-series Auto Electroflashes electronically switch the XG-M's shutter over for strobe exposures when charged and signal flash-ready in the finder; the 320X and 200X also enable continuous-sequence flash with the motors. Besides MD lenses, your XG-M uses virtually all interchangeable Minolta lenses to date and all applicable Minolta SLR system accessories.

Before using your camera for the first time, study this manual carefully all the way through — or at least all the sections needed to cover your own photographic needs. As you read, attach a lens to the camera body (see p. 8), load batteries, and handle your XG-M and acquaint yourself with its parts and features. Then load it with film and proceed to actual picture taking. In this way, you can take good photos and begin to realize the broad potential of your XG-M right from the start. Be sure to keep this manual for reference later as necessary.

This and the last page fold out to display the names of parts.

NAMES OF PARTS

Distance scale (p. 33, 35)

Focusing grip (p. 33)

Hot shoe (p. 42)

Control release (p. 29)

Exposure-adjustment control (p. 29)

Back-cover release knob (p. 12, 40)

Film-speed window (p. 16)

Rewind crank (p. 40)

Depth-of-field scale (p. 35)

Aperture scale (p. 22, 27)

Minimum-aperture lock (p. 23)

Main switch (p. 11)

Touch-switch/operating button (p. 11)

Shutter-speed/function selector (p. 22, 27)

Auto-setting release/battery-check button (p. 10, 22, 27)

Safe Load Signal (p. 15)

Frame-counter window (p. 15)

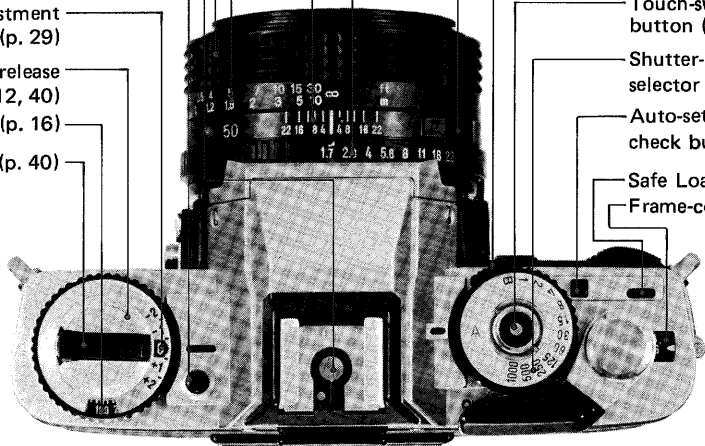

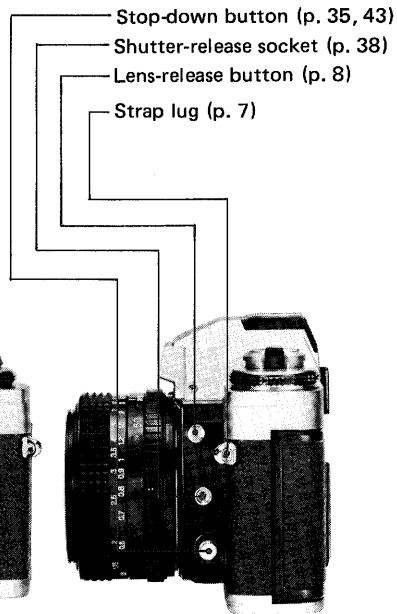
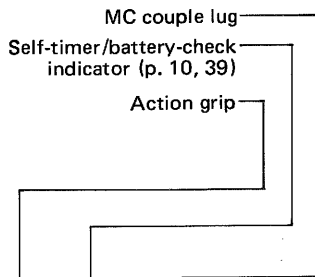
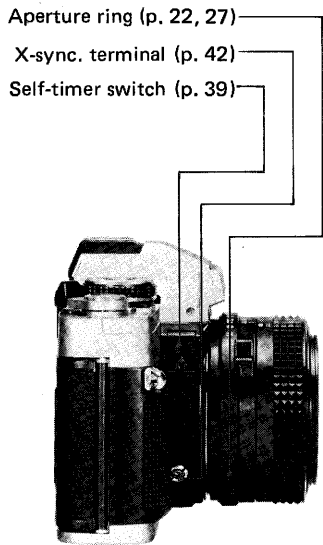

CONTENTS

MAIN FEATURES	3	VIEWFINDER	21
SUMMARY OF OPERATION		AUTOMATIC EXPOSURE CONTROL ...	22
(Automatic)	5	Automatic operation	22
NECK STRAP	7	Eyepiece cap	23
BATTERY HOLDER	7	WAYS OF USING AUTO MODE	24
ATTACHING AND REMOVING LENSES .	8	General use	24
BATTERIES AND POWER	9	Creative aperture control	25
Installing batteries	9	Creative shutter control	26
Testing batteries	10	METERED/MANUAL EXPOSURE	
Main switch	11	CONTROL	27
Touch-switch/operating button	11	Metered/manual operation	27
Cold-weather operation	12	"B" setting	28
LOADING AND ADVANCING FILM	12	EXPOSURE-ADJUSTMENT CONTROL ..	29
Film-advance lever and frame counter ...	15	WHEN AND HOW MUCH TO ADJUST	
FILM SPEED	16	EXPOSURE	30
Setting film speed	16	HOLDING THE CAMERA	32
ASA/DIN conversion table	17	FOCUSING	33
Memo holder	17	Depth of field	34
EXPOSURE-CONTROL		Depth-of-field preview	35
FUNDAMENTALS	18	Depth-of-field scale	35
METERING WITH THE XG-M	20		

Infrared index	36	Data Back G	48
Film-plane index	36	STANDARD-LENS SPECIFICATIONS ...	49
RELEASING THE SHUTTER	37	CAMERA SPECIFICATIONS	50
SELF-TIMER	39	CARE AND STORAGE	52
REWINDING AND UNLOADING			
FILM	40		
FLASH PHOTOGRAPHY	41		
Synchronization	41		
Connecting flash units	42		
USING OTHER THAN MD OR			
MC LENSES	43		
Auto Rokkor lenses and non-meter			
coupled accessories	43		
RF (mirror-type) and manual-preset			
lenses	43		
XG-M SYSTEM ACCESSORIES	44		
Motor Drive 1	44		
Auto Winder G	45		
X-series Auto Electroflashes	46		
Remote Cord S and L	47		

MAIN FEATURES

Fail-safe electronic exposure system

Incorporating many of the features developed for Minolta's top electronic cameras, the XG-M covers a wide range of photographic conditions. Its electronic shutter which automatically locks to prevent overexposure and electromagnetic shutter release with unique touch-switch metering add to the handling ease of the camera.

The XG-M's system features:

- Full automatic exposure by stepless shutter speeds from 1/1000 to 1 sec. plus metered/manual settings.
- Electromagnetic shutter release.
- Unique "Touch-switch" metering.
- Two tiny alkaline-manganese or silver-oxide batteries as power source.
- Electromagnetic shutter release that locks to prevent overexposure when light is over meter's range or when battery power too low.

Solid-state information viewfinder

- Special focusing screen has split-image and microprism focusing aids, plus scientifically developed new type of matte field that is up

to 50% brighter than conventional matte screens.

- Aperture set for automatic and manual modes visible in the finder.
- LED's indicate automatic shutter-speed selection, the shutter setting for proper exposure in manual operation, and over-/under-range warning.
- LED at "60" position blinks as flash-ready signal when X-series Auto Electroflashes are attached and charged.
- LED "M" signal lights when camera is set for manual mode.

Easy handling controls

Lightweight and compact, the XG-M is human engineered to fit the user's hands for smooth operation:

- Smooth short-stroke film advance.
- Large easy to adjust shutter-speed dial.
- "Soft-touch" electromagnetic shutter release.
- Minolta bayonet lens mount with large release button.
- Textured action grip.

- Easy-to-use depth-of-field preview button.

Quick-attach motor drive and auto winder

Both the Motor Drive 1 and Auto Winder G attach to the XG-M quickly, without access caps to remove or store. Single frame or continuous operation is available up to 3.5 fps for the Motor Drive 1, and up to 2 fps for the Auto Winder G. Two touch-switch operating buttons on the motor drive provide full LED readout for both horizontal and vertical operation. The motor of each unit automatically shuts off at the end of each cartridge and film can be easily rewound with the unit attached.

Special dedicated flash units

When attached to the XG-M and ready to fire, the X-series Auto Electroflashes start a flash-ready signal blinking in the viewfinder and automatically set the shutter for X-synchronization (1/60 sec.) when the shutter is released. Other individual features include thyristor circuitry for winder/motor synchronization and maximum battery life, tiltable head for bounce flash, filters for special effects, multiple aperture settings and full manual operation. From

the compact and economical 118X to the 320X with its exclusive Variable Guide-Number/Power Control, there is an X-series flash to meet any need.

User oriented features

- Up to two stops continuous adjustment over or under the normal electronic setting.
- X-type flash synchronization through the hot shoe or PC terminal.
- Electronic self-timer with blinking indicator light.
- Eyepiece cap for unmanned or similar operation.
- Exclusive Safe Load Signal monitors film alignment and advance.
- Handy memo holder and ASA/DIN conversion table on back.
- Release terminal for tripod shots with electronic or standard release cord.
- Shutter not operative when main switch off.
- Virtually all existing Minolta interchangeable lenses and applicable system accessories can be used in either automatic or manual operation.

SUMMARY OF OPERATION (Automatic)

The steps pictured on this page outline use of your XG-M on automatic mode. They give a general idea of how very easy it is to get perfectly exposed pictures with this camera and are keyed to corresponding sections of the manual for easy reference. This brief guide

may also be useful for good results after you have not used the camera for some time. It is not, however, a substitute for the detailed instructions in the rest of this manual, which should be thoroughly studied for best results.

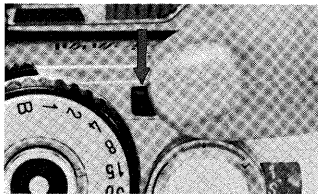

1. Check batteries (see p. 10)

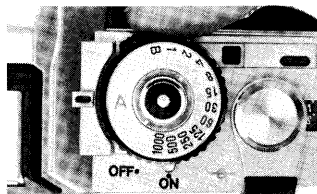

2. Move main switch to "ON" (p. 11)

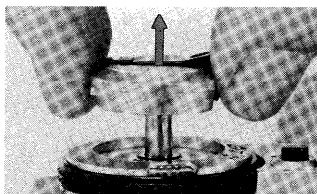

3. Open back cover (p. 12)

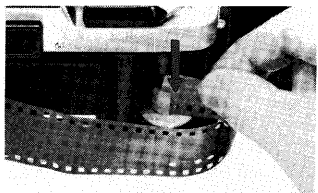

4. Load film properly; close cover (p. 13)

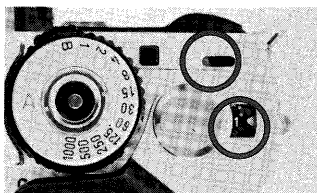

5. Advance film to "1" (p. 15)

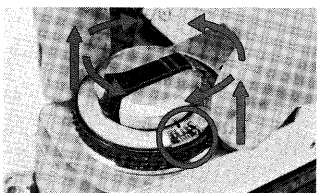

6. Set film speed (p. 16)

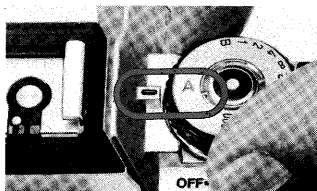

7. Set selector dial to "A"
(p. 22)



8. Set lens aperture (p. 22)



9. Adjust focus (p. 33)



10. Release shutter (p. 32, 37)

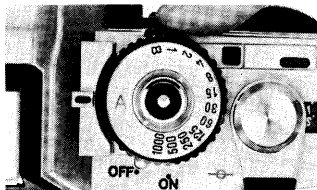

11. Turn power "OFF" (p. 11)

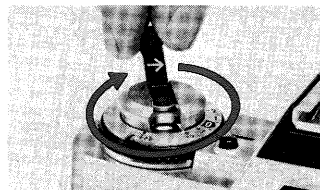

12. Rewind and remove film
(p. 40)

NECK STRAP

For carrying convenience and safety, this strap can be attached to the camera by means of the strap eyelets on the camera body.

To attach, follow the steps illustrated.

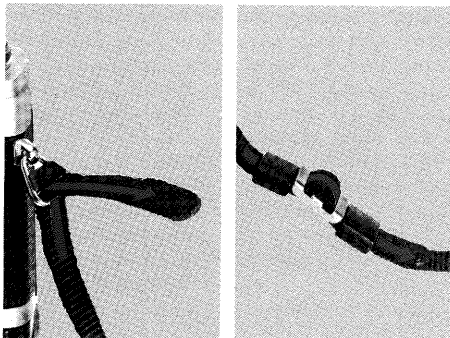

BATTERY HOLDER

A holder for carrying spare batteries is provided with this camera strap. To install batteries, follow the steps illustrated. Slide the holder off the strap to remove batteries.

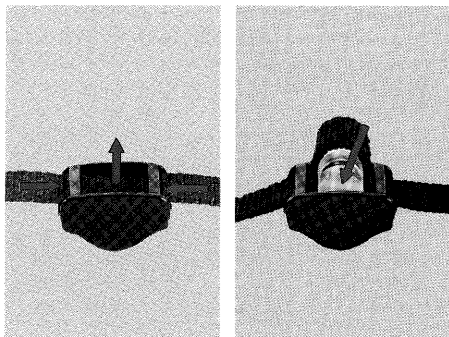

ATTACHING AND REMOVING LENSES

To Attach

1. Remove the body cap from the camera lens mount and the rear cap from the lens bayonet, each by turning the cap counterclockwise.
2. Align the red mounting index on the lens barrel with the red index above the camera lens mount; insert the lens bayonet into the mount; and turn the lens clockwise until it locks into place with a click.



To Remove

While pushing the lens-release button, turn the lens counterclockwise as far as it will go; then lift the lens bayonet out of the mount.

CAUTION

If it becomes necessary to set the lens down without a rear lens cap attached, be sure to set the lens only on its front end (except for fisheye lenses) as damage to the diaphragm control pin could result from rear lens contact with a hard surface.



BATTERIES AND POWER

Two 1.55v silver-oxide (Eveready EPX-76/S-75 or equivalent) or 1.5v alkaline-manganese (Eveready A-76 or equivalent) batteries, supply the power for the meter, electronic exposure control, electromagnetic release, electronic shutter settings, and LED indication.

CAUTIONS

- The shutter will not release when the operating button is pushed if: battery power is too low; the main switch is at "OFF," exposure conditions exceed the range of the automatic exposure system.
- Do not use 1.35v mercury batteries, Eveready EPX-675 or equivalent, which have a similar shape.
- Keep batteries away from young children.

NOTES

- If the camera is not to be used for more than two weeks, it is advisable to remove the batteries.
- Fresh spare batteries may be stored in the battery holder provided with the camera strap.

Installing batteries

1. Using a coin or similar object, turn the battery-chamber cover counterclockwise and remove it.
2. After wiping terminals with a clean dry cloth and handling only by the edges, insert two of the specified batteries plus (+) side out into the sleeve on the inside of the cover. (If batteries are inserted improperly, they will not make contact, and no current will flow.)

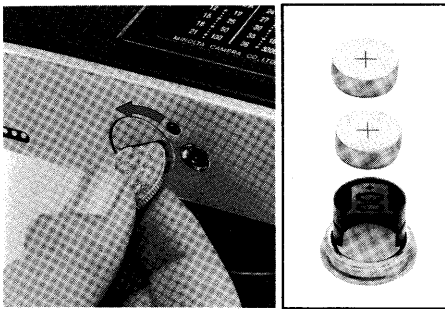

3. Replace the cover and screw it in clockwise as far as it will go.

CAUTION

Mixing of battery types, or using an exhausted battery with a fresh one could cause battery leakage or bursting.

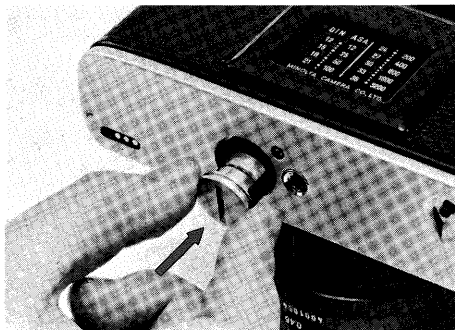

Testing batteries

Depress the Auto-setting release/battery-check button. If the red battery-check indicator on the front of the camera lights, batteries are serviceable.

Test batteries immediately after installing them. If the indicator does not light, make sure that they are fresh and have been inserted correctly.

Batteries should be tested from time to time thereafter, preferably before starting each new roll of film and particularly before starting picture-taking sessions or trips. A set of silver-oxide batteries will generally last for about one year in proper normal use.

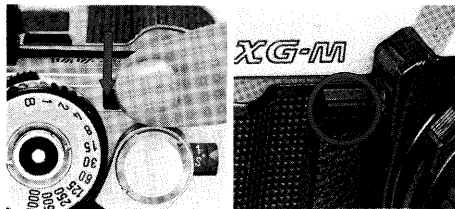

Main switch

To operate the camera, move the main switch to "ON." This allows current to flow to the Touch switch/operating button.

To prevent accidental exposures and needless battery drain, always be sure to move the main switch to "OFF" when not using the camera.

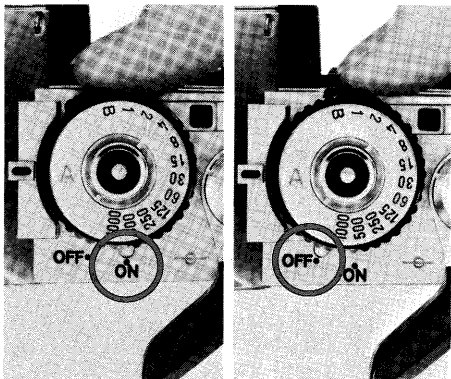

Touch switch/operating button

Finger contact with the Touch switch/operating button activates the camera's electronic exposure control and LED circuits. If proper contact with the touch switch is not possible (i.e., while wearing gloves or when fingers are dry), slight pressure on the button will also activate the camera.

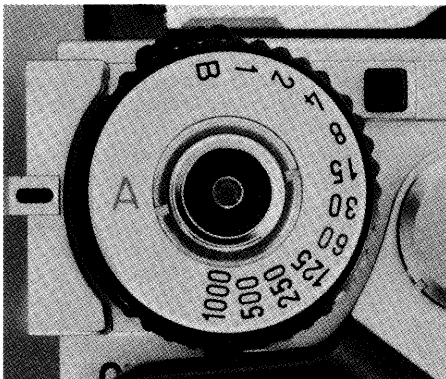

NOTE

Wipe off any dust or dirt that might accumulate on the touch switch with a clean dry cloth. This will insure good contact and proper operation.

Cold-weather operation

Batteries by nature tend to lose power as temperature drops. While the alkaline-manganese batteries will meet all requirements under normal conditions, for heavy sustained cold-weather operation (approx. -10°C) it is recommended that silver-oxide type batteries be used.

Regardless of which battery type used, remember to always use fresh batteries and keep a spare set with you when using your camera in cold-weather.

LOADING AND ADVANCING FILM

After you have not used your camera for some time, check the Safe Load Signal and frame counter to be sure that there is no film in the camera. If the camera is unloaded proceed as follows:

1. Pull out on the back-cover release knob until the camera back springs open.

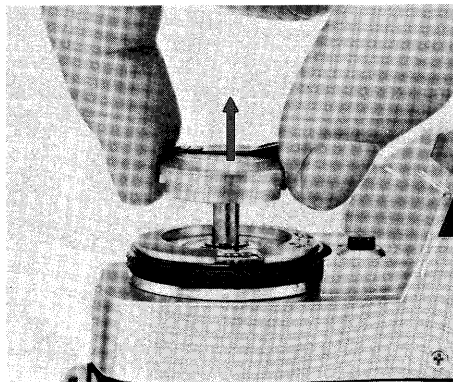

2. Leaving the knob pulled out, position a film cartridge in the chamber with the projecting-spool end toward the bottom of the camera. Then push the back-cover release knob all the way in, rotating it slightly to do so if necessary.

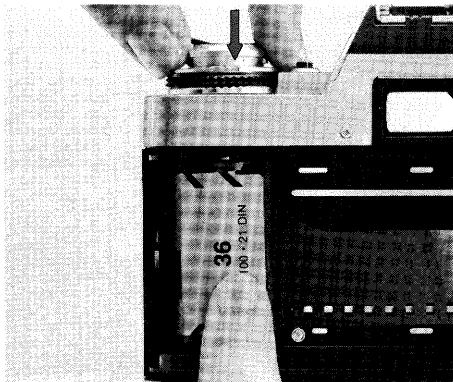

3. Insert the end of the film leader as shown into one of the slots in the take-up spool so that the tooth is engaged with a sprocket hole near the end of the leader. Make sure that the end of the leader does not project from another slot between tabs on the spool.

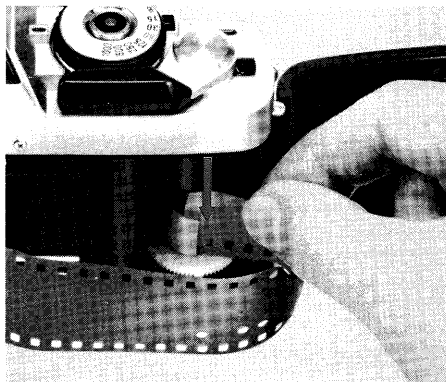

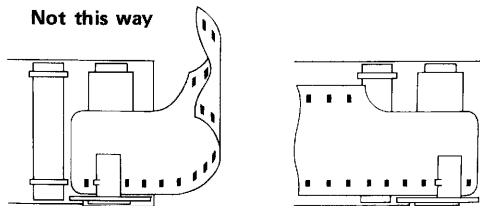
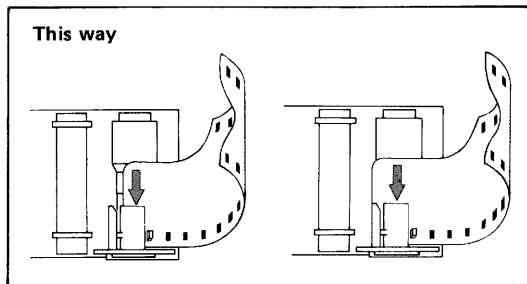

4. With the shutter-speed/function selector on manual setting, operate the film-advance lever slowly until the film has begun to wind firmly around the take-up spool and the sprocket teeth are engaged with holes on both edges of the film. If the advance lever stops at the end of a full stroke during this procedure, release the shutter and continue.

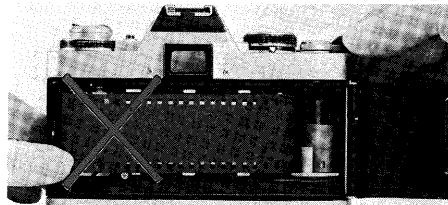
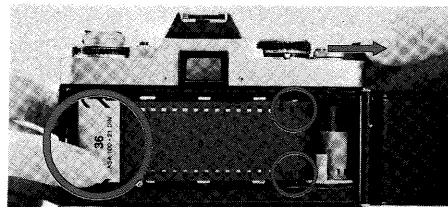

5. Close the camera back and push in on it until it clicks shut.
6. A red "S" should now appear opposite the index in the frame-counter window. Advance film and release the shutter until the index points to "1" on the frame-counter dial.
7. A red bar should also now appear at the extreme left in the Safe Load Signal window. This indicates that the film is loaded and winding properly on the take-up spool. If the Safe Load Signal does not appear or swings far to the right in the window, repeat steps 1 through 6 to assure that film is properly engaged on the spool. As you continue to take pictures, the red signal will move gradually toward the right in the window, indicating that film is advancing properly.

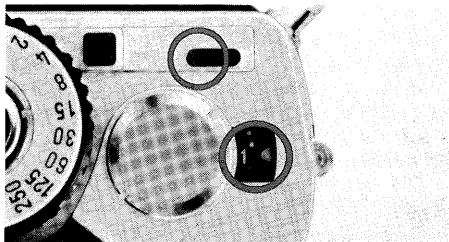

CAUTION

Film should be handled and loading done in subdued light — at least shaded from direct sunlight by the body.

Film-advance lever and frame counter

The film-advance lever is designed with 30° unengaged movement before the beginning of its engaged stroke to allow swinging it out from the body so that the right thumb will fit comfortably behind it. Continuing to move the lever until it stops, an angle of 130°, advances film and frame counter and cocks the shutter for the next exposure.

When the lever stops and resists further movement at the end of a film, never attempt to force it farther. (see p. 40 for instructions on rewinding and unloading film.)

The counter automatically resets for film loading when the camera back is opened.

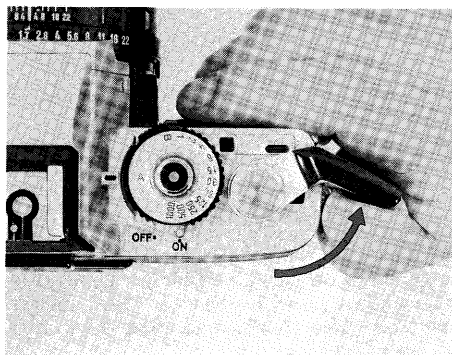

FILM SPEED

Each film on the market has an ASA or DIN exposure-index number to indicate its sensitivity to light. For correct exposure, the meter must be set for the effective exposure index of the film in use.

Setting film speed

To do this, lift up on the black ring of the exposure-adjustment control and turn it until

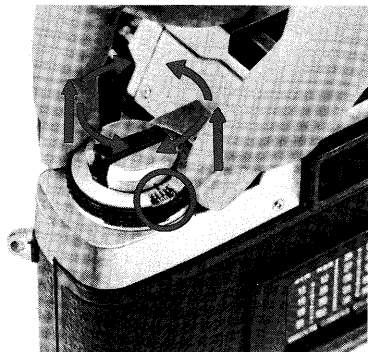

the proper ASA indication appears centered in the film-speed window and locks in that position when the ring is released. Marks between numbered graduations indicate ASA numbers as shown in the ASA/DIN conversion table below:

ASA		DIN		200		24
12		12	•	250		25
•	16	13	•	320		26
•	20	14	400			27
25		15	•	500		28
•	32	16	•	640		29
•	40	17	800			30
50		18	•	1000		31
•	64	19	•	1250		32
•	80	20	1600			33
100		21	•	2000		34
•	125	22	•	2500		35
•	160	23	3200			36

ASA/DIN conversion table

A convenient table for converting DIN to ASA film-speed ratings is located on the back cover of the camera.

Memo holder

Around the ASA/DIN conversion table is a convenient frame that can be used to keep memos handy with the camera. It is just the right size to hold the film-box end, which can be inserted as a reminder of the film in use.

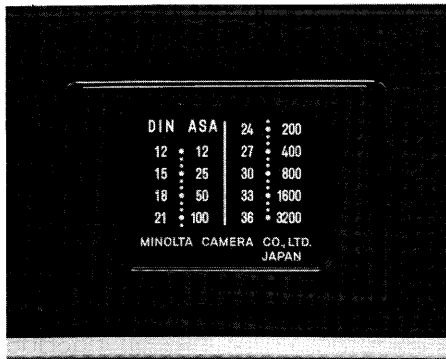

EXPOSURE-CONTROL FUNDAMENTALS

The two camera exposure-control settings are lens opening (aperture) and shutter speed. The size of the aperture determines the volume of light reaching the film from a given subject and lighting. The shutter speed determines the length of time this light acts upon the film. Apertures are expressed in f-numbers, which are larger for small openings and vice versa (e.g., f/16 represents a small opening, f/2 a large one). Shutter speeds are

(f/2 at 1/250 sec.)



expressed in seconds or fractions thereof, which are generally the reciprocals of the numbers shown on shutter-speed scales (e.g. 60 = 1/60 sec., and 2 = 1/2 sec.). At usual apertures, each f-number setting (e.g., f/8) lets in twice as much light as the next numerically larger one (f/11) and half as much as the next smaller (f/5.6). Similarly, each shutter speed (e.g., 1/60 sec.) allows light to strike the film twice as long as the next higher speed (1/125) and half as

(f/2.8 at 1/125 sec.)



long as the next lower one (1/30). The interval between two standard f-numbers (say, f/4 and f/5.6) or shutter speeds (say, 1/15 and 1/30) is one "stop." Total exposure on the film is determined by the combination of aperture and speed. Other things being equal, using the next smaller f-number (i.e., giving one stop more exposure) will balance using the next higher shutter speed (i.e., giving one stop less exposure), and so on. A great range of combinations

(f/4 at 1/60 sec.)

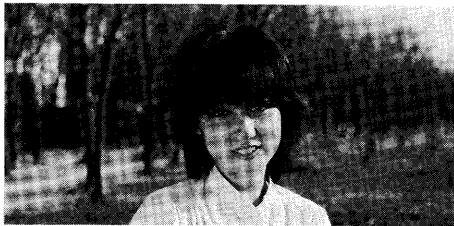

(e.g., f/5.6 at 1/30, f/4 at 1/60, f/2.8 at 1/125, f/2 at 1/250, etc.) will thus yield the same total exposure (see example photos below). The specific combination you choose under given lighting conditions will depend upon the degree to which you want the greater depth of field (see p. 34) of smaller apertures and the greater movement-blur preventing ability of faster speeds (p. 26).

(f/5.6 at 1/30 sec.)



METERING WITH THE XG-M

The center-weighted metering system in your XG-M employs two CdS cells mounted behind the pentaprism so that light from all parts of the viewfield (picture area) is measured but influence from a broad central area is greatest. Thus the reading should yield satisfactory exposure without adjustment as long as the main subject area occupies a major part of the frame.

If the subject area to be measured occupies a relatively small part of the frame, move the camera so that the main subject fills most of the frame. Note the shutter-speed setting in this position and compensate for the exposure difference with the exposure-adjustment control or use manual speeds to set the same value when making the exposure from the original position. Further, if the most important area is very much brighter or darker than the rest of the frame and does not fill most of it, exposure should be decreased or increased with

the same control from 1/2 to 2 stops, the exact amount varying with the specific brightness difference and the effect desired. (p. 29).

As with most metering systems, strong sources of direct light or other very bright areas may influence the reading adversely if allowed to dominate the frame.

Though your XG-M finder is designed to minimize the effect on the meter of light entering through the finder eyepiece under usual conditions, care must be exercised to prevent this especially if you wear glasses. Use of a rubber eyecup is further recommended when the subject is in shade and the camera is in sunlight, when bright sidelight falls between eye and eyepiece, or when stop-down metering is used, particularly at small apertures (see p. 43). When viewing is unnecessary, the eyepiece cap (see p. 23) can be used to completely eliminate this problem.

VIEWFINDER

As you look through the viewfinder of your XG-M, you can see:

- ① Split-image/microprism focusing spot,
- ② Shutter-speed scale,
- ③ Indicator LED's (show shutter speed being set to auto mode and correct exposure in manual mode when shutter-speed indicated agrees with speed manually set; LED at "60" also blinks as flash-ready signal with X-series Auto Electroflashes),
- ④ LED over- or under-range indicators,
- ⑤ F-number of lens aperture set, and
- ⑥ LED manual-mode indicator

For operation details, see the following section on exposure control and focusing.

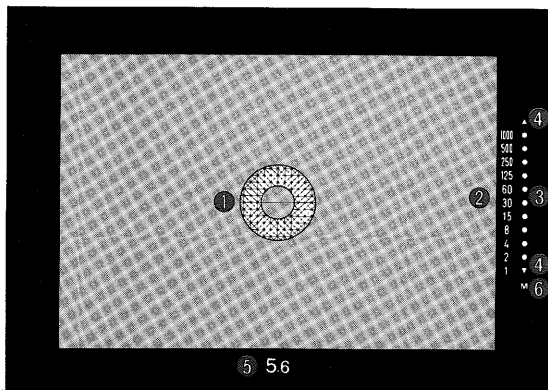

AUTOMATIC EXPOSURE CONTROL

Automatic operation

1. Turn the shutter-speed/function selector to align "A" with the index, at which point it is locked to prevent accidental movement.
2. Set the lens opening by turning the aperture ring on the lens barrel. The f-number set will appear centered below the frame in the finder, and the automatically set shutter speed will be indicated by lighted LED's when the operating button is touched. The shutter speed varies automatically to yield proper exposure for the aperture and other settings with the light being metered.
3. It is then only necessary to confirm focus (see p.33), compose your picture, and release the shutter (p. 37).

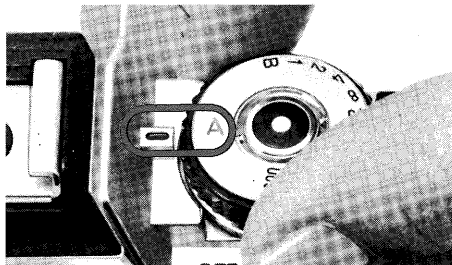

4. The XG-M's accurate range of shutter operation on automatic mode is 1/1000 to 1 sec., as indicated by the shutter-speed scale.

When the over-range indicator lights, the shutter will lock to prevent overexposure.

Lighting of the under-range LED indicates use of a shutter speed longer than one second. For either, the aperture or other conditions should be adjusted so that an LED lights within the scale's range.

NOTES

- **When the over-range indicator lights, be sure not to depress the operating button while adjusting the aperture or other conditions. This will cause the shutter to release at the instant the exposure is within metering range and result in an unwanted picture.**
- To continuously provide more or less exposure on automatic mode, see p. 29.
- New Minolta MD lenses have a minimum-aperture lock which is used with the shutter speed priority system found on XD cameras. This lock should be released when using your XG-M camera.

Eyepiece cap

For remote or unmanned operation or when the camera is set on a support and used without viewing on automatic mode or manual speeds longer than 1 sec., be sure to attach the eyepiece cap as shown. This will prevent unwanted light from entering through the eyepiece and affecting the meter reading and exposure when the eyepiece is not being shielded by the photographer's head, as it normally would be.

The eyepiece cap has a slot that allows threading it on the camera strap to avoid loss and keeps it handy for use.



WAYS OF USING AUTO MODE

On AUTO mode, your XG-M will set the precise shutter speed for proper exposure for you automatically. Even so, you have considerable control over results and can adjust, aperture and shutter speed over considerable ranges to suit the conditions and yourself.

General use

For good pictures with a minimum of care where no particular effect is desired, simply set the aperture as indicated in the table. These guide settings will provide as much depth of field (see p. 34) as possible while producing a shutter speed fast enough to stop any subject motion and guard against blur from camera movement (see p. 37).

Guide to setting aperture

	Sunny	Hazy Sun	Heavy Over-cast	Indoors
ASA 25	f/8	f/4	f/2	f/1.4
ASA 80	f/11	f/5.6	f/4	f/1.4
ASA 100	f/11	f/5.6	f/4	f/1.4
ASA 200	f/11	f/8	f/5.6	f/2
ASA 400	f/16	f/11	f/8	f/2.8

(These are only guidelines for typical picture taking situations. For additional information see page 18).

NOTE

Use of a steady support (p. 37) or an electronic flash (p. 41) is recommended for use with shutter speeds of 1/60 or slower.

Creative aperture control

There may be times when it will be most important to set the lens aperture to obtain a particular effect, such as rendering a certain range in sharp focus or emphasizing a subject against an out-of-focus background. In this case, set the desired aperture, and let the

camera select the shutter speed. Small f-numbers yield a shallow field of sharp focus, as in example A below, while large f-numbers give greater depth of field, as in example B. To determine actual depth of field, use the depth-of-field scale (see p. 35).

A: Large lens opening



B: Small lens opening



Creative shutter control

At other times, the subject or effect you want may make the shutter speed more important. In this case, turn the aperture ring until the lighted LED indicates the required speed on the finder scale; exposure will automatically be correct. High shutter speeds such as 1/500 to 1/1000 sec. can "freeze" fast action, as in

C: High shutter speed



example C below. Such slow speeds as 1/2 to 1 sec. can be used to emphasize subject flow or motion, as in example D.

No matter how the camera is used, it is important to support it (see p. 32) and release the shutter properly (p. 37).

D: Low shutter speed

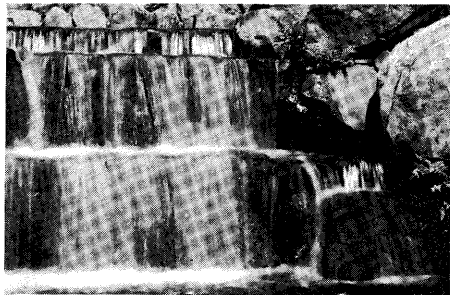

Metered/manual operation

In situations where the contrast difference between the subject area and the background exceeds the available range of automatic exposure compensation, or when a desired photographic effect requires a fixed speed, you will want to use the XG-M's manual shutter speeds.

1. While depressing the Auto-setting release if from the "A" setting, turn the shutter-speed/function selector to align a stepped speed with the index.

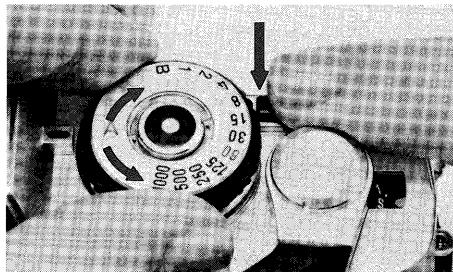

2. To set proper exposure for light as metered, touch the operating button and turn the aperture ring until an LED lights next to the number on the shutter-speed scale that corresponds to the shutter-speed setting in use. If necessary agreement cannot be achieved, adjust the shutter-speed setting or other conditions to permit it. A red "M" will light below the shutter-speed scale to indicate that shutter speeds are no longer being set by the camera's automatic exposure-control system.

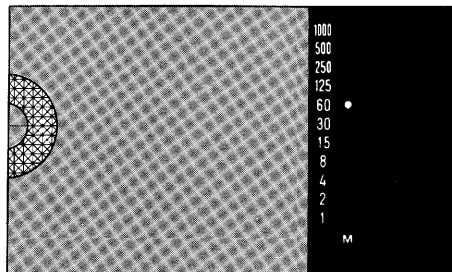

3. Number agreement can of course be disregarded and any shutter-speed and lens-aperture combination set for full manual operation.

"B" setting

Turning the shutter-speed/function selector to align "B" with the index (while depressing the Auto-setting release if from "A" setting) sets the camera for making "bulb" exposures. That is, the shutter will open when the operating button is depressed and remain open until it is released.

NOTE

When using a standard cable release with the XG-M and "B" setting, be sure not to let any metal part of the release touch any metal part of the camera body while the shutter is open as this will cause the shutter to close and end the exposure.

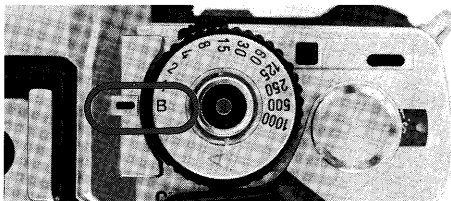

EXPOSURE-ADJUSTMENT CONTROL

To deliberately give more or less exposure while in automatic mode, set the exposure-adjustment control as follows:

Depress the control release and move the exposure-adjustment control so that the index is aligned with plus (+) numbers to produce more exposure or with minus (–) numbers to produce less exposure. The numbers indicate the amount of adjustment in stops or EV steps (i.e., “+1” indicates one more stop or double the normal automatic exposure, and “+2” means two stops or four times more exposure; “–1” is one stop less or one half the exposure,

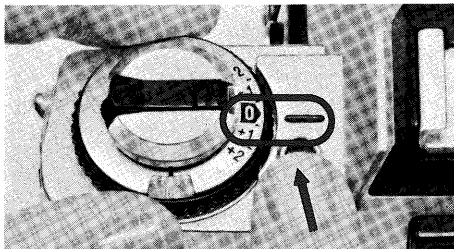

and “–2” produces two stops’ less or one quarter the normal exposure). The exposure-adjustment control will lock at “0” and each half-stop setting.

Always align “0” on the exposure-adjustment control with the index after using exposure-adjustment settings.

NOTE

When using a R60 (red) filter, set the exposure-adjustment control for +1/2 more than the normal exposure.

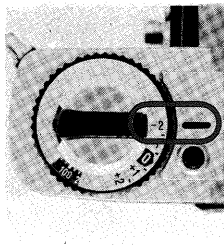
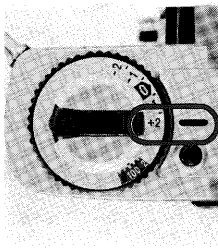

WHEN AND HOW MUCH TO ADJUST EXPOSURE

1. In situations where there is a great contrast difference between the subject and background and the most important area is considerably darker than the area surrounding it, set the exposure-adjustment control at from $+1/2$ to $+2$. Examples of such pictures are ones with strong backlighting and no fill-in illumination, such as examples A and B, or subjects against a background of snow or light-colored sand, unless the bright area occupies a very small part of the image frame.
2. If the most important subject area is much brighter than the rest of the picture, set the exposure-adjustment control from $-1/2$ to -2 . Examples of this kind of picture are subjects in a spotlight or shaft of sunlight, or against a very dark background, as

A: Without adjustment



B: Exposure increased



examples C and D, unless the background occupies only a small area in the image frame.

3. As above, when copying documents printed on white stock or other subjects that are predominantly light in color, an adjustment to $+1/2$ or more may be called for. Similarly, you will probably want to make an adjustment from $-1/2$ to -2 for predominant-

ly dark copy material, or that on a dark background.

4. The above suggestions will serve as starting points for trial; individual conditions and taste will of course determine exact final exposure.

C: Without adjustment



D: Exposure decreased



HOLDING THE CAMERA

Holding the camera securely when exposures are made is as important as focusing. Even slight movement at the instant of exposure can result in "blurred" photographs, especially when operating with slow shutter speeds. A recommendable way that permits ready operation of important controls is shown here.

To hold the camera horizontally, cradle the bottom of it in the palm of the left hand with the thumb and index or middle finger on the focusing grip of the lens. These fingers can also be used to turn the aperture ring. Grasp the camera body firmly with the right hand as

shown so that the index finger rests on the operating button. In this position, the thumb can conveniently operate the film-advance lever.

The camera may be held in a vertical position as shown (center) using the thumb of the right hand to push the shutter release while the left hand is used for support and focusing. Another possibility is to rotate the camera from the horizontal position and hold it so that the rewind-crank end is cradled in the left hand as shown.

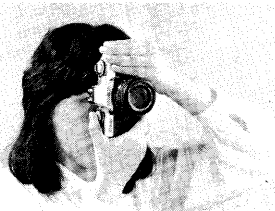

FOCUSING

The focusing screen of your XG-M features a split-image spot surrounded by a band of microprisms in the center of an acute matte field.

To focus the camera visually with usual lenses, look through the viewfinder with lens at full aperture and turn the focusing collar on the lens until the upper and lower subject images in the spot are exactly aligned with no broken lines between them and/or the subject image in the band does not shimmer or appear broken up. At this point, the subject image within the focusing aid should appear clearest and seem to blend with that on the matte field around it.

Out of focus

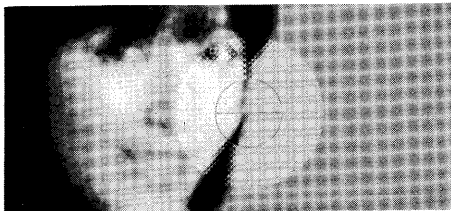

Though the most satisfactory focusing aid and method depend upon the conditions and personal preference of the photographer, the above method may provide the best results with medium wideangle to medium telephoto lenses.

Generally speaking, however, you will probably find that using the split-image spot will provide the easiest way to focus with subjects having vertical lines; the microprism band for lenses from medium wideangle through medium telephoto, especially with subjects not having vertical lines; and the matte field for longer lenses or macro or other work involving considerable lens extension.

Subject in focus



Depth of field

The distance behind and in front of the focused distance within which the image appears acceptably sharp is called the depth of field.

It extends a greater distance behind the focused distance than in front and is determined by three factors: the aperture size, the distance at which the lens is focused, and the focal length of the lens in use. Depth of field increases as the lens is stopped down (e.g., $f/2$ to $f/16$) and becomes greater the farther from the camera the lens is focused. It decreases as the lens is opened up (e.g., $f/16$ to $f/2$) and the closer to the camera the lens is focused. Depth of field is greater for short focal length lenses than for telephoto's at the same focused distance and aperture. It is at its least for any given lens in normal mounting when the lens is at maximum aperture (as when metering and focusing normally with Minolta MD- or MC-type lenses) and at minimum focusing distance.

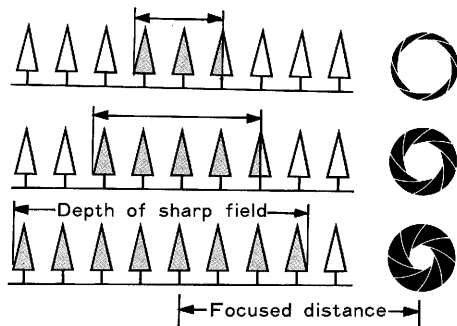

(f/2.8)

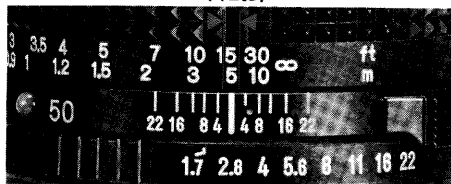

(f/8)

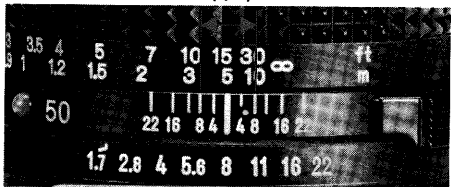

(f/22)

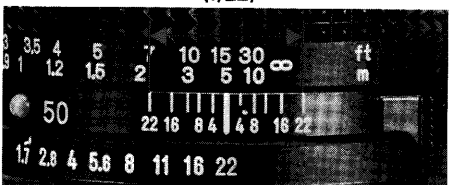

Depth-of-field preview

Depth of field at any aperture and focusing distance can be previewed visually by pushing the stop-down button all the way in. This will stop the diaphragm down to the aperture corresponding to the f-number preset on the aperture ring, allowing you to see through the viewfinder how much of the subject is acceptably sharp.

Depth-of-field scale

The near and far limits of acceptable sharpness can be determined from the depth-of-field scale on the lens barrel. With the lens focused at a given point, the image will be in satisfactory focus from the nearer value to the farther value on the distance scale indicated by the depth-of-field scale marks for the aperture to be used (see pictures at left).

Infrared index

For proper focus when making pictures with infrared radiation, first focus your subject with visible light as described above, then attach a red filter and turn the focusing ring to the right to align the point of proper focus on the distance scale with the index designated with small red dot (earlier MD lenses have an "R" instead of a dot) in the depth-of-field scale. When making color pictures, follow the manufacturer's recommendations to set focus.

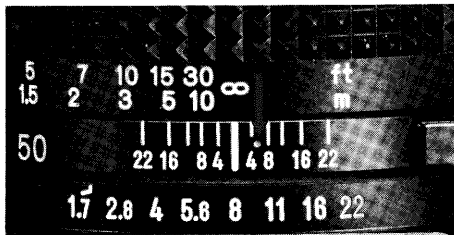

Film-plane index

The symbol on the camera top plate to the right of the viewfinder indicates the exact plane occupied by the film in the camera. This can be used to measure distance from subject to film.

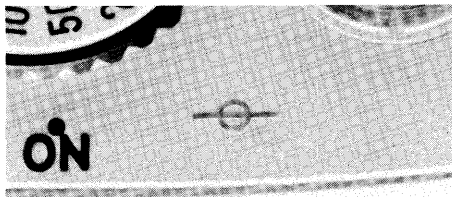

RELEASING THE SHUTTER

The way the camera is supported (see p. 32) when exposures are made and how the shutter is released are as important as focusing for best photographic results, and to avoid blurred pictures due to camera movement during exposure these factors become more critical the slower the shutter speed.

You may wish to use the figure "60" on the shutter-speed scale as the reference point to gauge the chance of camera movement. When the LED lights below it, you should pay special attention to both camera and subject movement in taking pictures.

With the possible exception of highest speeds, the camera or hands holding it should generally be firmly steadied against your face or body when you release the shutter.

At slower speeds, it is advisable to steady the camera against a doorframe, post, or other firm support while depressing the release.

The shutter should always be released with a slow, steady squeeze — never a quick jab — preferable while holding your breath.

DANGER OF BLUR FROM CAMERA/SUBJECT MOVEMENT

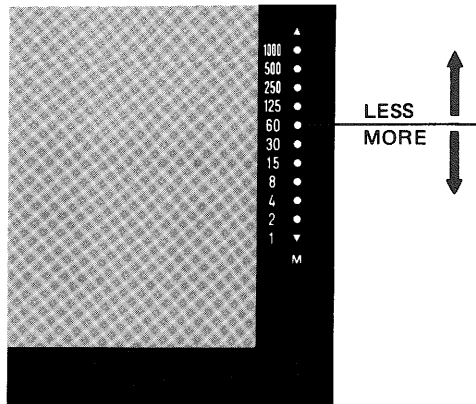

For maximum sharpness when making exposures too long to permit hand-holding the camera, mount it on a tripod using the built-in socket on the bottom and trip the shutter with a Minolta electronic Remote Cord or a standard cable release screwed into the threaded socket provided on the side of the lens mount. Do not

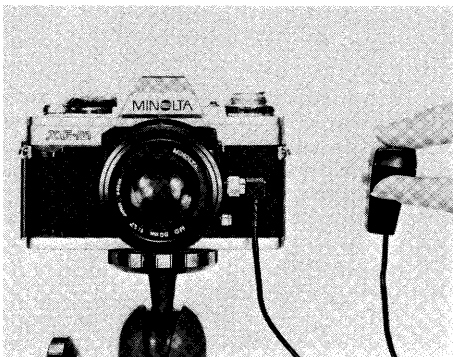

use excessive force when attaching the camera to a tripod.

If the eyepiece is not being shielded by the photographer's head when the shutter is released in this way, the eyepiece cap should be used (see p. 23).

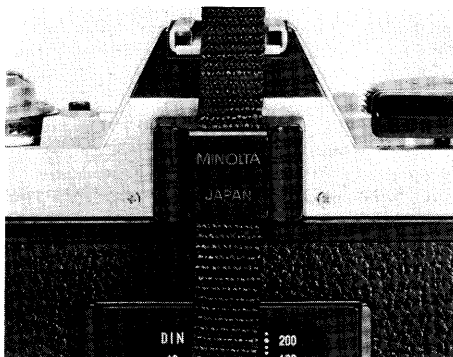

The electronic self-timer built into your XG-M can be used to delay release of the shutter for about 10 seconds after actuation.

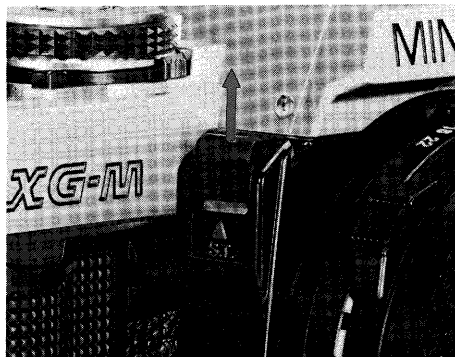

To operate it:

1. Advance the film.
2. With the shutter-speed/function selector is at any setting other than "B," move the self-timer switch in the direction of the arrow.
3. Depress the operating button. The blinking light on the front of the camera will indicate the delay has been started. Approximately 2.5 secs. before the exposure is made, the indicator will blink faster to signal the end of the delay. You may cancel the self-timer by moving the main switch to "OFF".

NOTES

- After using the self-timer be sure to move the self-timer switch to its off position.
- In automatic mode the self-timer will cancel if exposure conditions exceed the upper range of the metering system. Operation will resume when aperture or other conditions are adjusted so that exposure conditions are within metering range.

REWINDING AND UNLOADING FILM

1. Push the rewind button.

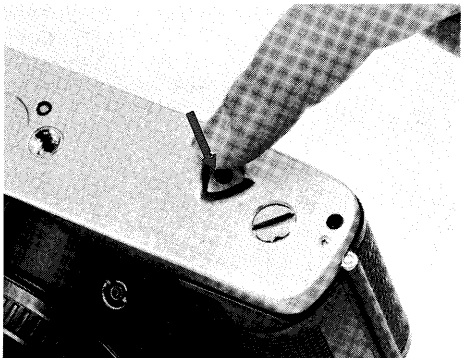

2. Unfold the rewind crank and turn it in the direction indicated by the arrow on it until the red Safe Load Signal bar moves out of the window to the left. You will then feel tension on the film increase and disappear, and the crank will turn freely.

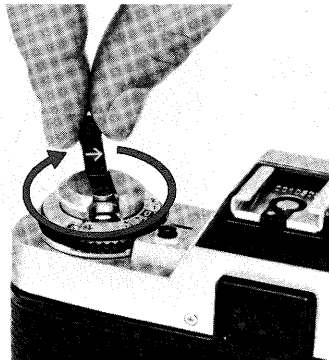

FLASH PHOTOGRAPHY

Synchronization

Your XG-M has shutter contacts for X-flash synchronization as follows:

- When you are certain that the film is completely rewound, pull out the back-cover release knob to open the back and remove the cartridge.

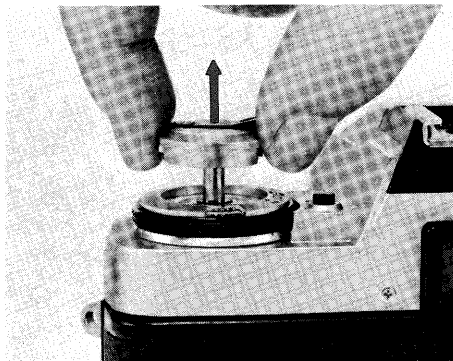

Type of flash	Synchronized speed range in seconds
	On manual mode (step speeds)
Electronic flash ("strobe")	1 through 1/60, B
Class M or MF flashbulbs	1 through 1/15, B
Class FP flashbulbs	1 through 1/15, B

NOTE

As indicated by the table, 1/60 is the maximum shutter speed for proper X synchronization. Slower speeds can also be used under certain conditions if desired for particular effects. Be sure not to use speeds faster than 1/60, (i.e. 1/125 and upward) with electronic or auto-flash units.

Connecting flash units

Cordless clip-on flash units such as the Auto Electroflash 200X are attached and electrically connected by simply sliding them into the camera's hot shoe. Sync. cords of either clip-on or bracket-type conventional units requiring them must be plugged into the camera's sync. terminal for operation.

Bracket-type flash units are attached to the camera by means of its tripod socket.

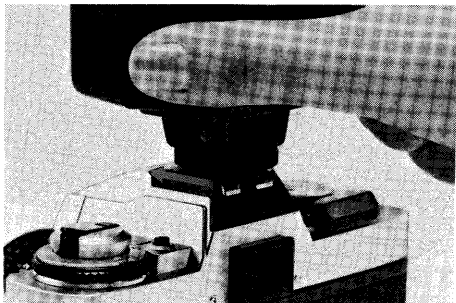

Metering and exposure with Auto Rokkor lenses having built in preview buttons, non-meter coupled accessories, RF lenses (reflex-mirror type), and manual-preset lenses are by the stop-down method as follows:

Auto Rokkor lenses and non-meter coupled accessories

1. After focusing, depress the preview button to stop down the aperture.
2. Use automatic or manual mode as on p. 22 or 27, respectively. The viewfinder field will darken as the lens is stopped down, and the split-image spot and micoprism band may become unusable due to darkening.
3. Leave the lens stopped down to the proper taking aperture when releasing the shutter.

RF (mirror-type) and manual-preset lenses

Proceed as for Auto Rokkors and non-meter coupled accessories above, except that use of a stop-down button is not necessary as metering and exposure are always made at taking aperture.

NOTE

The working automatic shutter-speed range for the XG-M used with non-meter coupled lenses and accessories is as indicated in the table below. Be sure not to use a shutter speed outside this range as improper exposure may result.

Film speed	Working range
ASA 25 to 50	1 to 1/1000 sec.
ASA 100	1/2 to 1/1000 sec.
ASA 200	1/4 to 1/1000 sec.
ASA 400	1/8 to 1/1000 sec.
ASA 800	1/15 to 1/1000 sec.
ASA 1600	1/30 to 1/1000 sec.

XG-M SYSTEM ACCESSORIES

Motor Drive 1

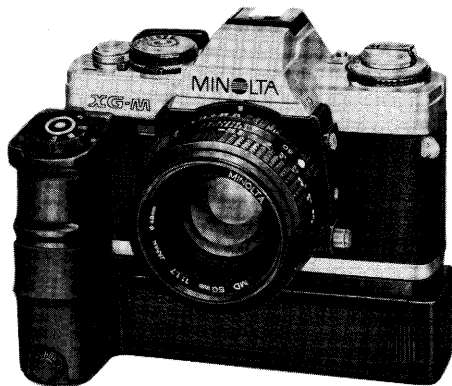

With the XG-M's accessory Motor Drive 1, you're always ready to capture fast breaking action. Attaching it is quick and easy with no access caps to remove or store. A switch on the grip sets the motor for single frame or continuous operation up to 3.5 fps. The hand grip's Touch-switch/operating button enables full viewfinder readout. A second release button is provided for vertical operation. The motor-drive mechanism stops automatically at the end of each cartridge and film can be easily re-wound with the motor attached.

Auto Winder G

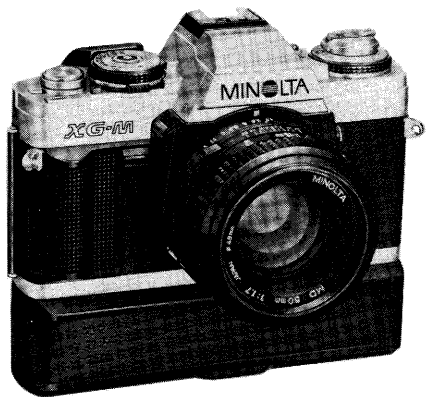

The Auto Winder G is an automatic film winder that helps the photographer focus his full attention on the creative aspects of photography by removing the interruption of having to wind the film after each picture. Attaching is quick and easy with no access caps to remove or store. Just a light touch of the shutter release is all that is required to take either successive or single frames with the winder automatically advancing the film after each one. The winder drive mechanism stops automatically at the end of each cartridge and film can be easily re-wound with winder attached.

All of these features combine with the XG-M to help you to capture the fast paced action of a sports car race or the fleeting expressions of a child at play.

X-series Auto Electroflashes



To make taking flash pictures as simple and easy as it is to take normal shots with your XG-M, Minolta offers four automatic electronic flashes designed especially for your camera.

All of the four X-series Auto Electroflashes feature dedicated-flash functions that electronically set the camera for proper X-sync, and activate a blinking flash-ready signal in the viewfinder when the flash is charged and ready to fire.

This and other individual features make the Auto Electroflash line-up the most comprehensive offered by any camera manufacturer. Thyristor circuitry for winder synchronization and maximum battery life (200X and 320X), bounce flash (132X and 320X), filters for special effects (132X and 320X), multiple auto-aperture settings and manual mode (all models), and Ni-Cd battery power supply (all models) are just a few of the features available to you in the X-series line.

From the compact and economical 118X to the 320X with its complete accessory flash system and exclusive Variable Guide-Number/Power Control, there is an X-series flash to meet any need.

Wireless Controller IR-1 Set

The IR-1 set is designed for remote operation of Minolta SLRs and 8mm cine cameras. The receiver senses near-infrared rays emitted from the transmitter and transfers a release signal to the camera, permitting remote control from distances up to 60 meters. When used with extra receivers, the three-channel transmitter allows independent operation of up to three cameras with receivers set to different channels, or simultaneous operation of an unlimited number of cameras with receivers set to the same channel.



Remote Cord S and L

These cords are designed for operating the XG-M from a distance. Each screws into the shutter release socket on the side of the lens mount. The Cord S is 50cm (about 20 in.) long, while the Cord L is 5m (16-1/2 ft.). These cords facilitate shots mounted on a tripod or remote wildlife pictures. In combination with the Motor Drive 1, or Auto Winder G, the Cord L can be used to make single or continuous sequence exposures at the subject position, from a remote location, etc.

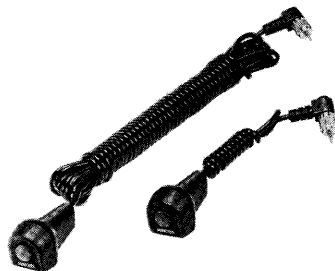

Data Back G



This convenient accessory imprints the date or other useful data on the film as the exposure is made to help identify or classify your pictures. It attaches in place of your XG-M's removable regular back cover and synchronizes with the shutter by means of a cord which is inserted into the camera's sync. terminal. Three large dials set numbered day, month and year indications which appear in reverse order on the bottom right corner of the picture. The ability to set letters and blank spaces further increases the data back's usefulness for scientific and other purposes. A red LED which also operates as a battery check, lights to signal when data is imprinting. Data-exposure intensity can be adjusted for either normal or high-speed black-and-white or color film. Power is provided by two tiny alkaline-manganese or silver-oxide cells.

STANDARD-LENS SPECIFICATIONS

Lens:	50mm f/2 MD	50mm f/1.7 MD	50mm f/1.4 MD	50mm f/1.2 MD
Type:	Standard lens			
Construction:	6 elements in 5 groups		7 elements in 6 groups	
Angle of view:	47°			
Min. focusing dist.:	0.45m (1.48 ft.)			
Diaphragm:	Fully automatic, meter-coupled			
Aperture scale:	2, 2.8, 4, 5.6, 8, 11, 16, 22	1.7, 2.8, 4, 5.6, 8, 11, 16, 22*	1.4, 2, 2.8, 4 5.6, 8, 11, 16	1.2, 2, 2.8, 4, 5.6, 8, 11, 16
	Each with full and half-click-stops			
Filter thread diam.:	49mm			55mm
Dimensions:	φ64mm x 36mm (φ2-1/2" x 1-7/16")		φ64mm x 40mm (φ2-1/2" x 1-9/16")	φ65.5mm x 46mm (φ2-9/16" x 1-13/16")
Weight:	155g (5-7/16 oz.)	165g (5-13/16 oz.)	235g (8-5/16 oz.)	310g (10-15/16 oz.)

* Earlier MD's minimum aperture is 16.

SPECIFICATIONS

- Type: 35mm single-lens reflex with automatic aperture priority and metered/full-manual exposure control
- Lens mount: Minolta SLR bayonet, 54° rotating angle; coupling for full-aperture-metering and automatic diaphragm control with Minolta MD and MC lenses (Standard lenses MD 50mm f/1.2, f/1.4, f/1.7 or f/2; see p. 49 for specifications)
- Auto-exposure control: Special low-voltage, low-current computer circuit, actuated by contact or pressure on "touch-switch" operating button, varies the shutter speed continuously and steplessly to yield proper exposure according to metering system indication at the aperture, film speed, and exposure adjustment set
Auto-exposure range: EV 2 to EV 17 (e.g., 1/2 sec. at f/1.4 to 1/1000 at f/11) at ASA 100 with f/1.4 lens
- Shutter: Horizontal-traverse focal-plane type; electronically controlled speeds; 1/1000 to 1 sec., steplessly on automatic mode or in steps on manual mode
- Metering: Full-aperture TTL center-weighted type by two CdS cells mounted on either side of the eyepiece at the rear of the pentaprism
- Film-speed range: ASA 25 to 1600 set by the exposure-adjustment control ring
- Auto-exposure adjustment: Up to ± 2 EV adjustment of automatic exposure with lock at each 1/2 EV setting and "O"
- Mirror: Oversize quick-return type (P0 value: 123mm)
- Viewfinder: Eye-level fixed pentaprism type showing 93% of 24 x 36mm film-frame area
Magnification: 0.9X with 50mm standard lens focused at infinity;
Power: -1D, variable with accessory snap-on eyepiece correction lenses.
Fresnel-field focusing screen having an artificially regular-patterned matte field plus central split-image horizontally oriented focusing spot surrounded by microprism band

- Visible in finder: stepless speeds indicated by 10 light-emitting diodes; LED over-/under-range indicators; LED at "60" position also blinks as flash-ready signal with the X-series Auto Electroflashes; f-number set for automatic and manual modes; manual-mode signal
- Flash sync.: PC terminal and hot shoe for X-sync. (disconnected when no unit installed): Electronic flash synchronizes at 1/60 sec. and slower step or stepless speeds; Class MF, M and FP flashbulbs synchronize at 1/15 or slower speeds. Extra contact on hot shoe receives signal from camera-control contact of Auto Electroflashes
- Film advance: Motorized: Through built-in coupler key with accessory Motor Drive 1 or Auto Winder G
Manual: By lever with single 130° stroke after 30° unengaged movement
Rewind button for rewinding; advancing-type frame counter and Safe Load Signal that indicates film loading and advancing conditions
- Power: Two 1.55v silver-oxide or 1.5v alkaline-manganese cells contained in camera base power both auto exposure control and shutter's electronically governed operation.
LED battery-check indicator lights when auto-setting release/battery-check button is depressed
Shutter will not release when voltage too low for proper operation
- Self-timer: Electronic, LED indicated types; approximately 10 sec. delay
Other: 4-slot take-up spool; detachable back cover with memo holder and ASA-DIN conversion table; Integral grip
- Size and weight: 52 x 89 x 138mm (2-1/16 x 3-1/2 x 5-7/16 in.)
515g (18-3/16 oz.) without lens and power cells
- Accessories: Exclusive Motor Drive 1, Auto Winder G, Auto Electroflash 320X, 200X, 132X and 118X, Data Back G, Wireless Controller IR-1 Set, Remote Cord S 50cm (20-in.) and Remote Cord L 5m (16-ft.); MD, MC, and other interchangeable Minolta lenses and applicable Minolta SLR system accessories.

CARE AND STORAGE

- As with all high-precision instruments, no part of your XG-M should ever be forced at any time. If operation is not as you think it should be, carefully restudy the applicable instructions or consult an authorized Minolta service representative.
- Always keep your camera in its case with the lens capped when not in use.
- Never subject your camera to shock, high heat and/or humidity, water, or harmful chemicals or gases.
- Never lubricate any part of the body or lens.
- Always use a body cap when a lens is not installed on the body. Keep lenses, properly capped front and rear, in their cases when not in use.
- Never touch the shutter curtains or anything inside the front of the body with the fingers. These parts and the inside of the back should be dusted with a soft brush from time to time as necessary, with particular care never to exert pressure on the shutter curtains.
- Never touch lens or eyepiece surfaces with the fingers. If necessary, remove loose matter from them with a blower lens brush. Use special photographic lens tissue or a soft clean cloth to remove smudges or fingerprints with a gentle circular motion. Only if absolutely necessary, the tissue may be moistened very slightly with not more than one drop of a satisfactory quick-evaporating fluid cleaner specially compounded for photographic lenses. Such fluids must never be dropped directly on the glass surface.
- Never lift the mirror or touch its surface, as doing so might damage the alignment. Small smudges of fingerprints on the mirror will not affect the meter reading or image quality; if they are very annoying, have the camera cleaned at an authorized Minolta service facility.
- External camera and lens-barrel — but not glass — surfaces may be wiped with a soft, silicone-treated cloth.
- Never leave the shutter cocked when the camera is to be stored overnight or longer. It is advisable to operate the film advance and release the shutter once or twice from time to time during extended storage.

- If the camera is not to be used for more than two weeks, the batteries should be removed.
- If the camera is to be stored for a long period of time, body and lens should be returned to their original packing and kept in a cool, dry place away from dust or chemicals, preferably in an airtight container with a drying agent such as silica gel.
- It is recommended to have your camera cleaned once per year at an authorized Minolta service facility.

Minolta Camera Co., Ltd.

Minolta Camera Handelsgesellschaft m.b.H.

Minolta France S.A.

Minolta (UK) Limited

Minolta Vertriebsgesellschaft m.b.H.

Minolta Nederland B.V.

Minolta (Schweiz) GmbH

Minolta Svenska AB

Minolta Corporation

Head Office

Los Angeles Branch

Chicago Branch

Atlanta Branch

Minolta Canada Inc.

Head Office

Montreal Branch

Vancouver Branch

Minolta Hong Kong Limited

Minolta Singapore (Pte) Ltd.

30, 2-Chome, Azuchi-Machi, Higashi-Ku, Osaka 541, Japan

Kurt-Fischer-Strasse 50, D-2070 Ahrensburg, West Germany

357 bis, rue d'Estienne d'Orves, 92700 Colombes, France

1-3 Tanners Drive, Blakelands, Milton Keynes, Buckinghamshire MK14 5BU, England

Grenergasse 45, A-190 Wien, Austria

Zonnebaan 39, Postbus 264, 3600 AG, Maarssenbroek-Maarssen, The Netherlands

Riedhof V, Riedstrasse 6, 8953 Dietikon-Zürich, Switzerland

Brännkyrkagatan 64, Box 17074, S-Stockholm 17, Sweden

101 Williams Drive, Ramsey, New Jersey 07446, U.S.A.

3105 Lomita Boulevard, Torrance, CA 90505, U.S.A.

3000 Tollview Drive, Rolling Meadows, IL 60008, U.S.A.

5904 Peachtree Corners East, Norcross, GA 30071, U.S.A.

1344 Fewster Drive, Mississauga, Ontario L4W 1A4, Canada

376 Rue McArthur, St. Laurent, Quebec H4T 1X8, Canada

1620 W. 6th Avenue, Vancouver, B.C. V6J 1R3, Canada

Oriental Centre Ground Floor, 67-71 Chatham Road South,

Kowloon, Hong Kong

110, Middle Road #07-01, Chiat Hong Building, Singapore 0718

Specifications subject to change without notice

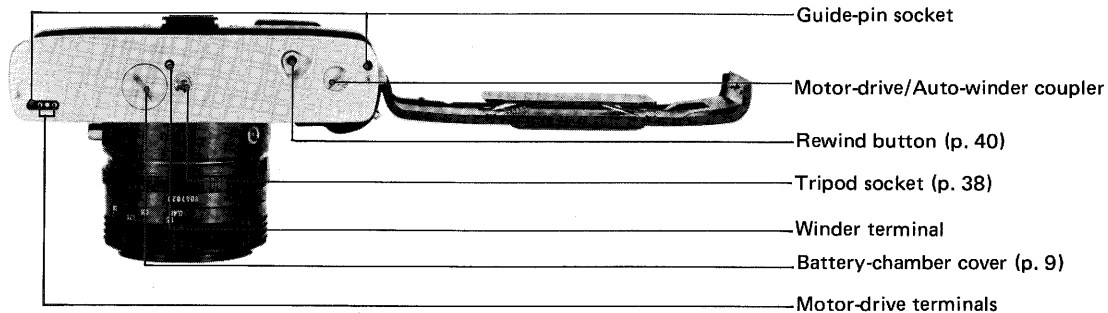
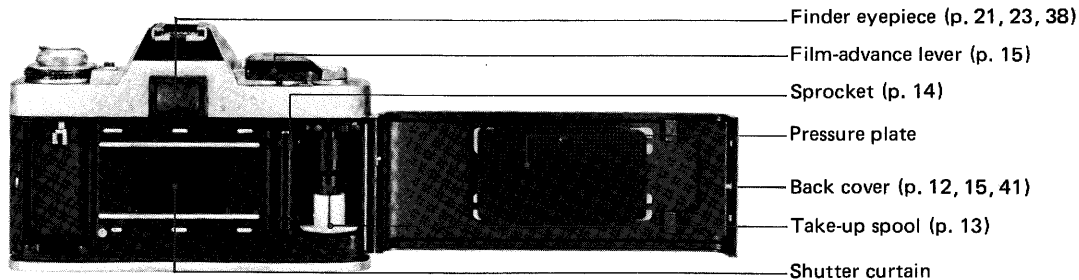





MINOLTA